







**CL.1 Deck-mounted basin spout without pop-up waste - Brushed Champagne (22kt Gold)**

CL.1

13 714 705



- 160mm projection
- fixed spout
- rectangular spray pattern with 40 individual jets
- height of mixer 108 mm
- height up to aerator 94 mm
- hole diameter 35 mm
- 2x screw-in M 10 x 1 pressure hose, leak-tested
- 1/2" connection
- max. flow 4 l/min
- lead-free
- This product can help a building meet the requirements of Green Building Rating Systems, e.g. LEED®, BREEAM®, DGNB

	Brushed Champagne (22kt Gold)	13 714 705-46
	Chrome	13 714 705-00
	Brushed Platinum	13 714 705-06
	Dark Chrome	13 714 705-19
	Champagne (22kt Gold)	13 714 705-47
	Brushed Dark Platinum	13 714 705-99

13 714 705  
mm [inches]

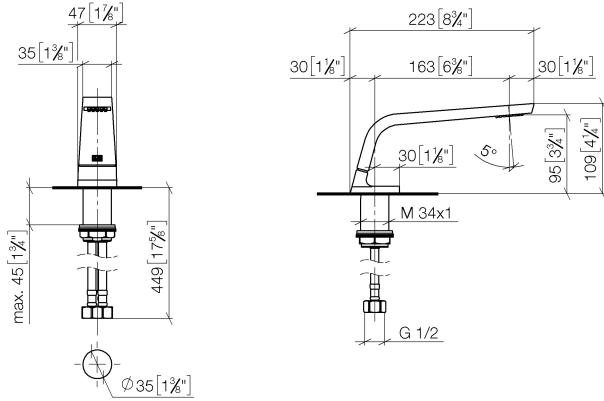

**Flow rate chart**

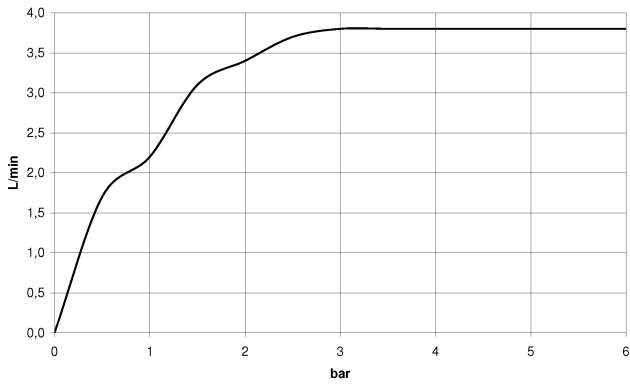

**Codes & Standards**

ASME  
A112.18.1/CSA  
B125.1

California Energy  
Commission  
(CEC)

NSF/ANSI 372

NSF/ANSI/CAN  
61



CL.1 Deck-mounted basin spout without pop-up waste - Brushed Champagne  
(22kt Gold)

---

CL.1

13 714 705

Certificates

---

GDV\_0400279.

IAPMO\_N-4976.

IAPMO\_6397.

CL.1 Deck-mounted basin spout without pop-up waste - Brushed Champagne  
(22kt Gold)

CL.1

13 714 705  
Parts for other  
finishes can be found  
here: Chrome

